

ENFOLD / ENFOLD WORK TABLE

ASSEMBLY INSTRUCTION

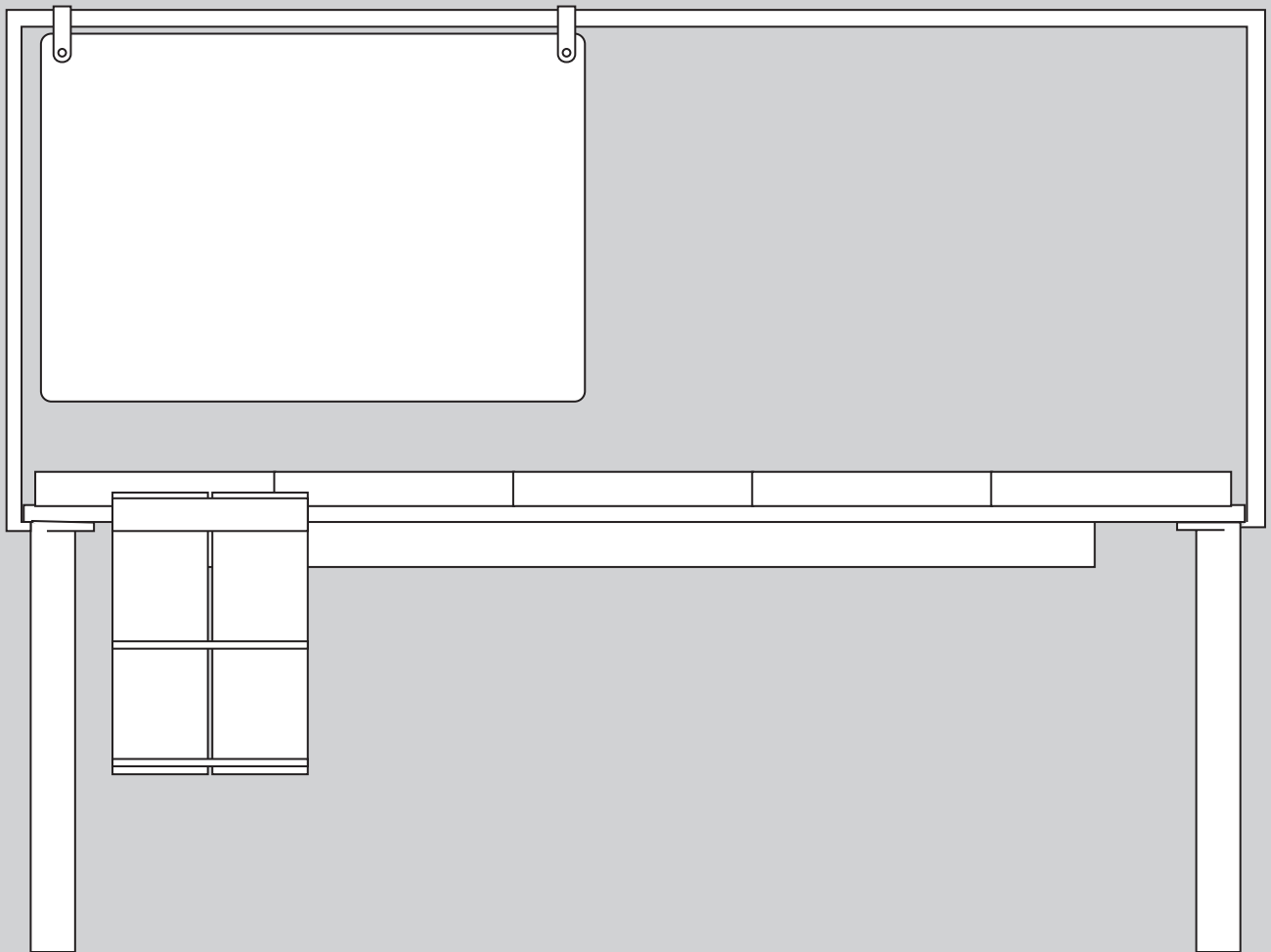

PARTS

Enfold table includes:

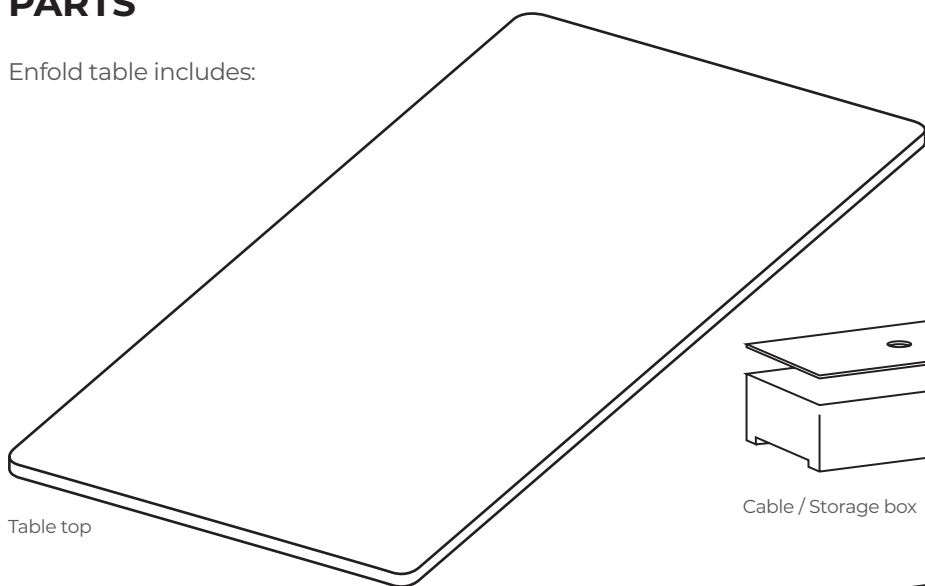
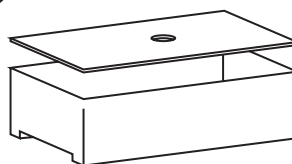
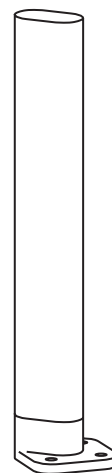

Table top



Cable / Storage box



Leg
x4pcs

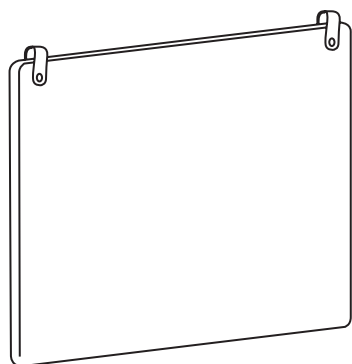

Sound absorber

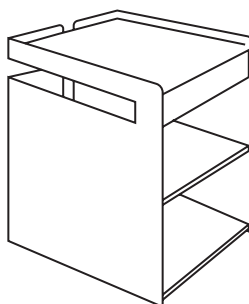

Ledge

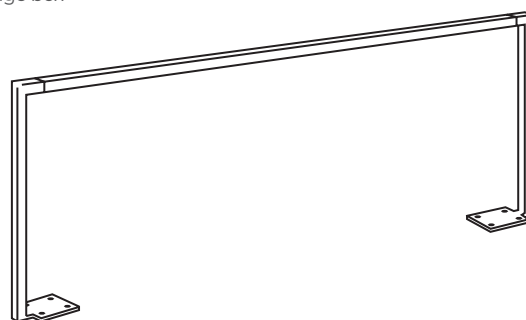

Linear beam

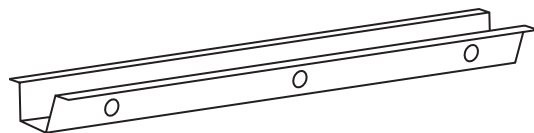

Cable holder

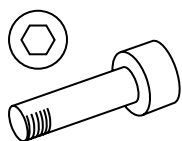

Allen bolt
6x25mm x12
FOR LEGS

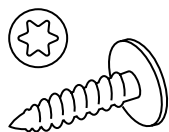

Wood screw
3x16mm x8
FOR CABLE HOLDER

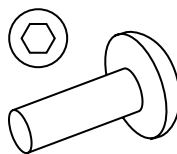

Allen bolt
6x16mm x8
FOR LINEAR BEAM

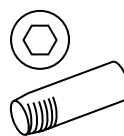

Set screw
8x20 x4
FOR LINEAR BEAM

TOOLS

To assemble Enfold you need the following tools.

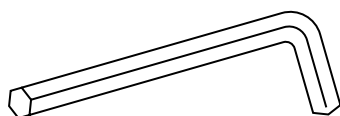

Nr 5 Hex key

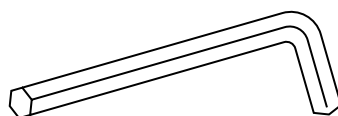

Nr 4 Hex key

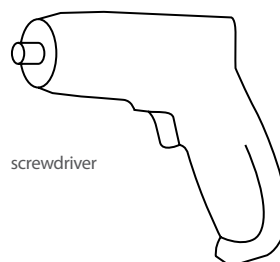

screwdriver

ASSEMBLE ENFOLD TABLE

The construction is easy to assemble with few parts.

1. MOUNT THE LEGS

Start by insert the screws by hand. When all screws are in place tighten all screws with the allen key.

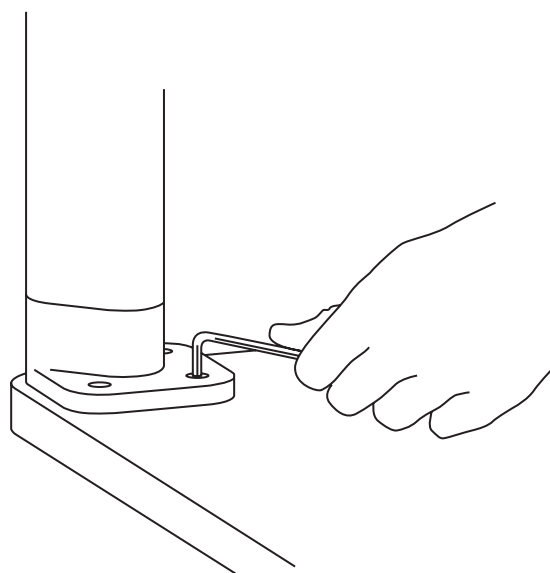
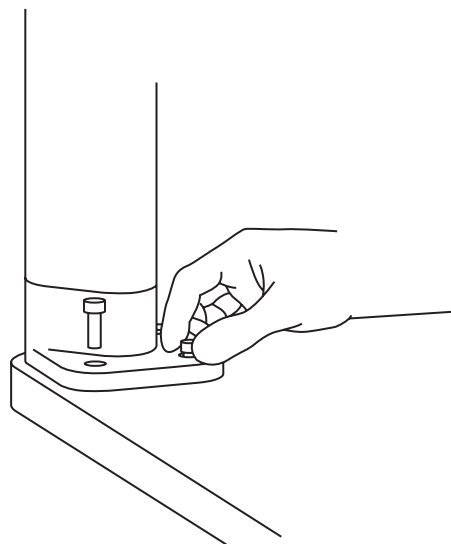

2. MOUNT THE CABLE HOLDER

Place the cable holder and fixate the screws using a electric screwdriver.

Be careful NOT to have the screwdriver in drill-mode. This may harm the table top.

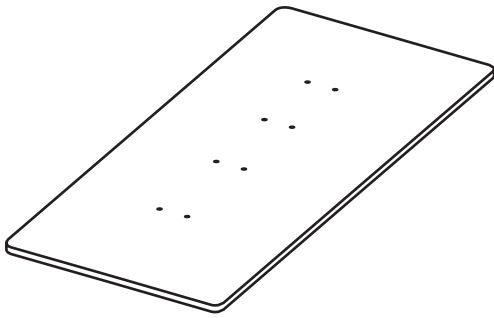
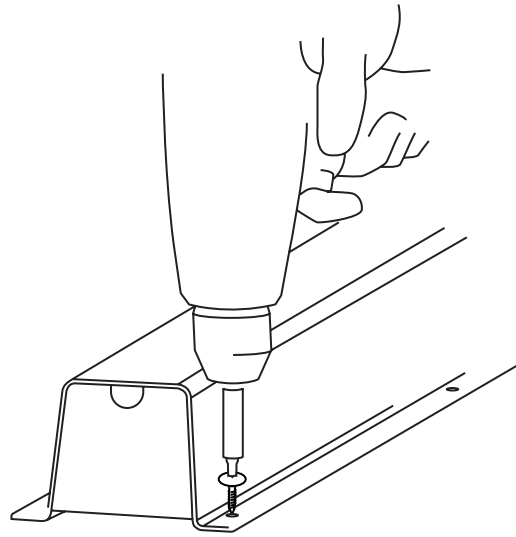

3. FLIP THE TABLE

When all legs are fastened and the cable holder in place flip the table.

Two people are needed to flip the table to avoid damage or injury.

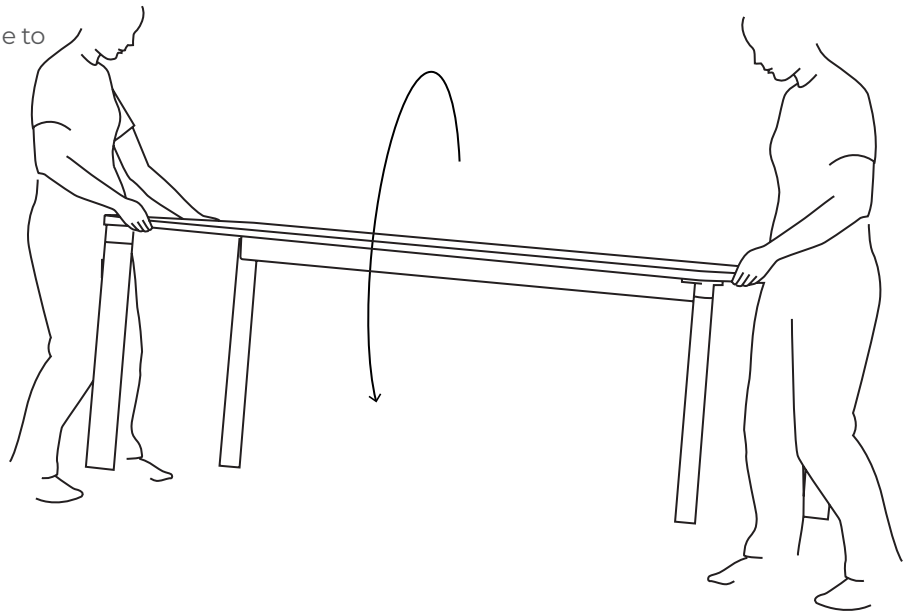

4. MOUNT THE LINEAR BEAM

If a linear beam is to be installed, mount the vertical beams under the table. Start by attaching bolts by hand. Then tighten all bolts with the allen key.

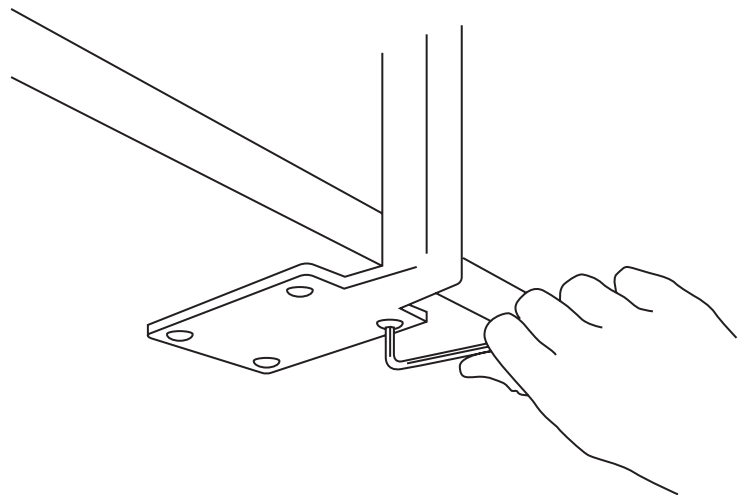
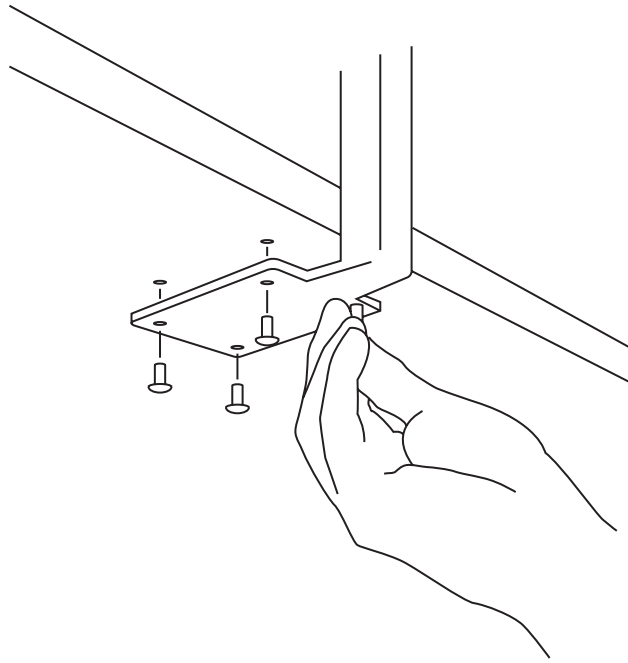
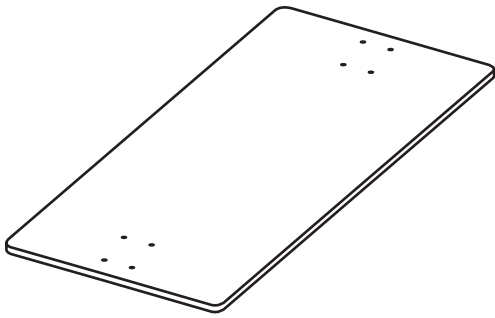

5. PREPARE THE VERTICAL BEAM

When the vertical beams are fixed insert the lock-plates and secure them with the set screws.

Do NOT tighten them.

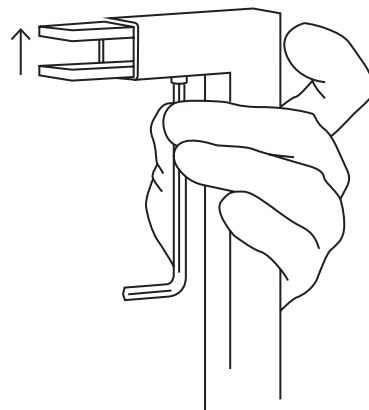

6. MOUNT THE HORIZONTAL BAR

When the lock-plates are inserted on both sides slide on the horizontal bar.

Secure one side at the time and press the horizontal and vertical bar together and tighten the lock-plates with the allen key.

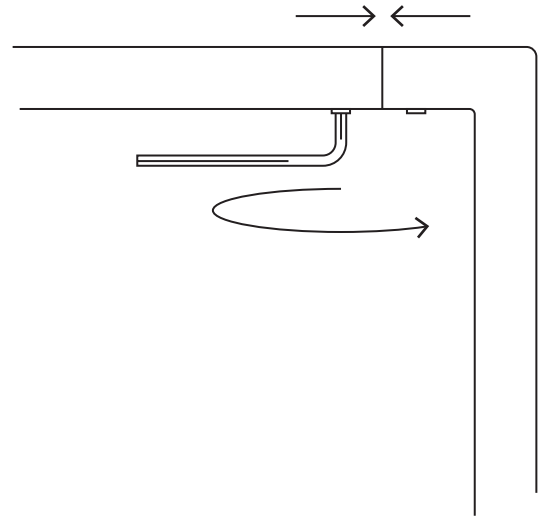
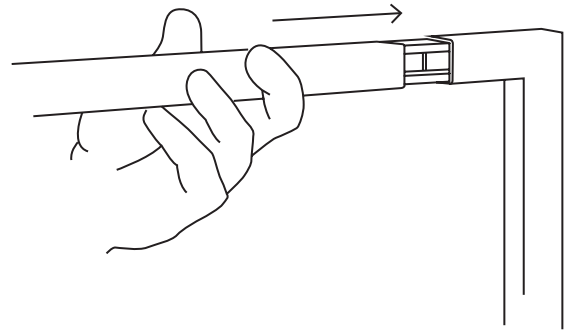

7. ATTACH THE SOUND ABSORBER

If a sound absorber is included use the bottoms on the leather straps to secure it around the linear beam.

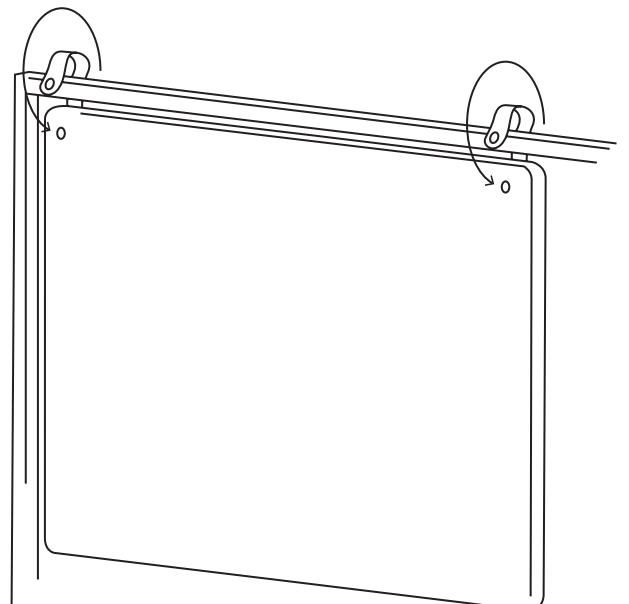
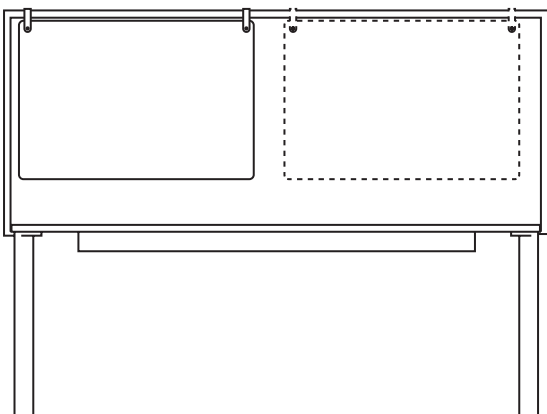

8. PREPARE THE TOOLBOX

If toolboxes or cable boxes are included attach two magnets using the adhesive tape on ONE side of each box.

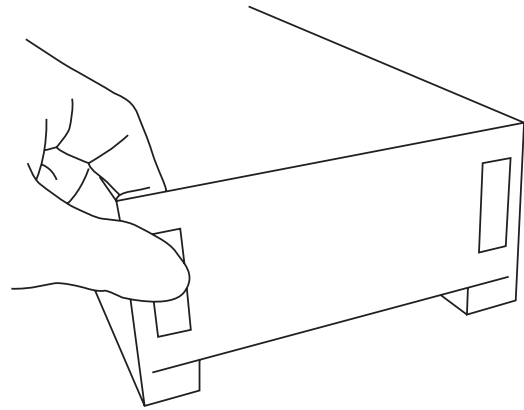
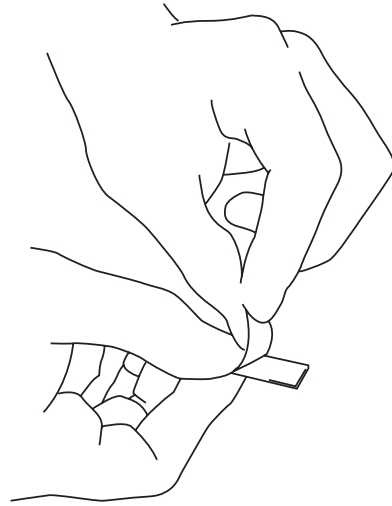

9. ATTATCH THE LEDGE

If a ledge is included, just slide it into place.

