

BIN THERE L

SET

ASSEMBLY INSTRUCTION

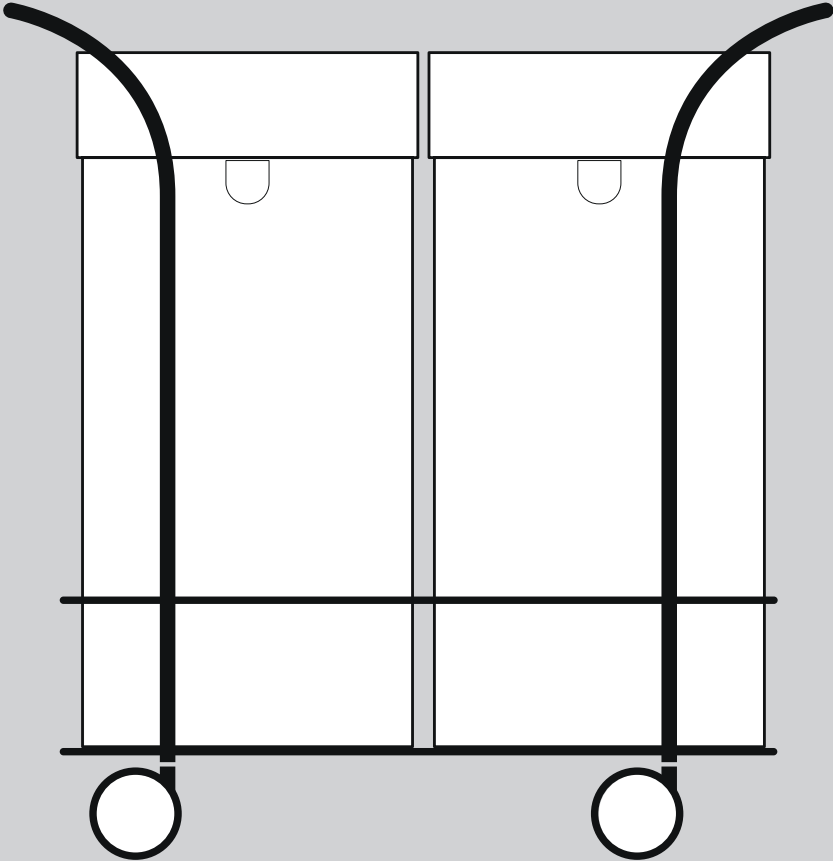

PARTS

Bin There L Set include 2 bins, 1 trolley and 4 wheels.
You can add wooden lids and drip trays.

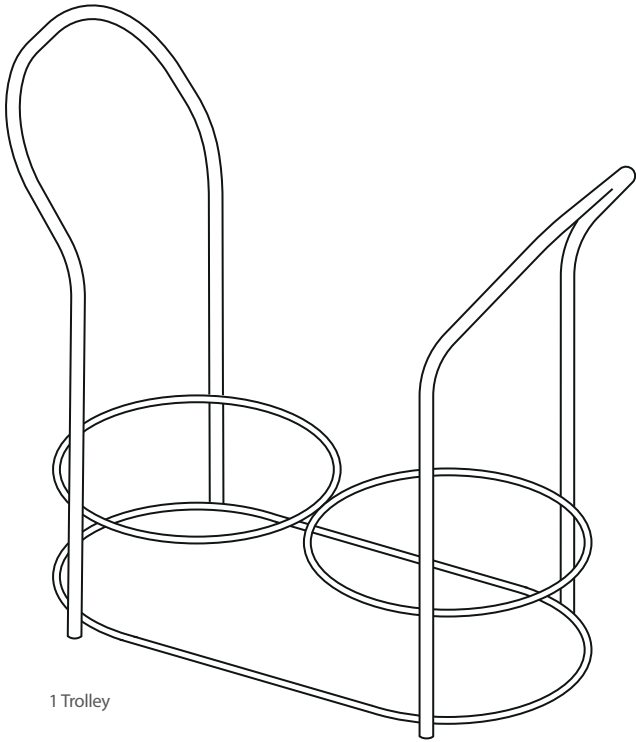

1 Trolley

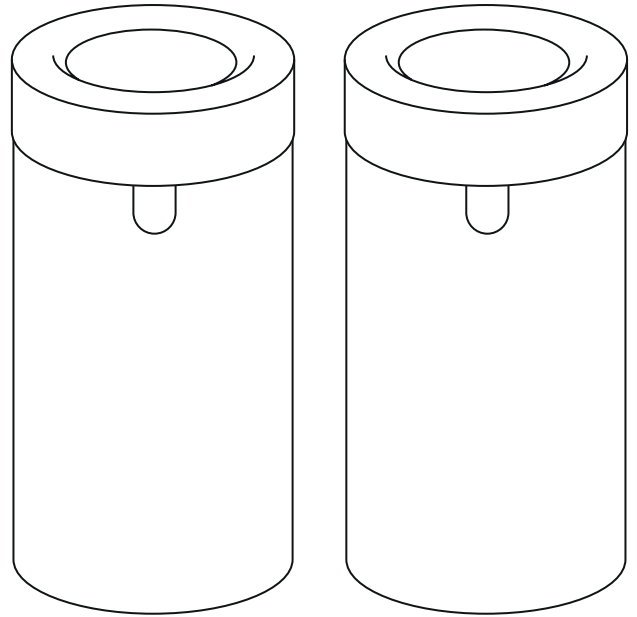

2 Bins



4 Wheels

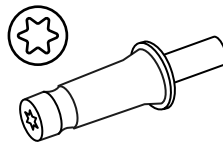

Wheel bolt
x4pcs



Bin There Lid



Bin There Drip Tray

TOOLS

To assamble the wheels to the trolley you need a torx T20.

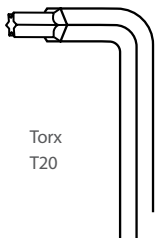

Torx
T20

ASSEMBLE BIN THERE L

The construction is easy to assemble with few parts.

1. MOUNT THE WHEELS

To fasten the wheels **remove the bins** and lay the trolley on its side.

- A.** Screw in the wheel axis. Use wheel bolt.
- B.** Press the wheels until they snap into place.

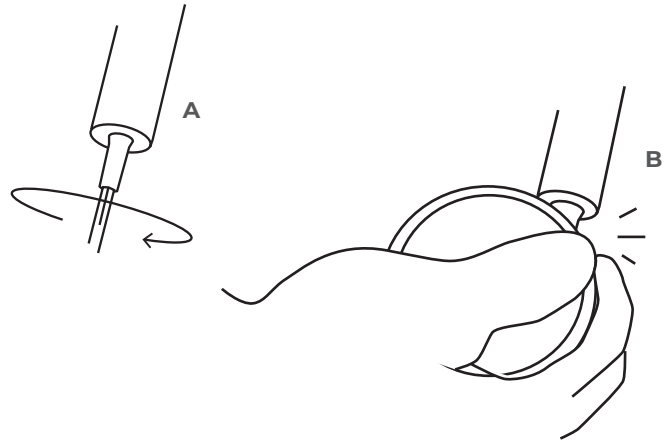

2. PLACE THE BINS

Place the bins in the trolley.

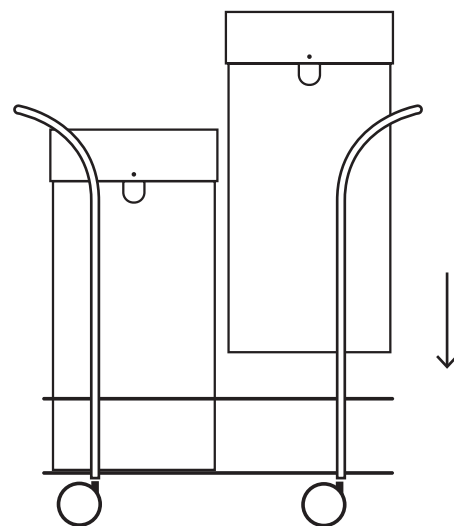

3. INSERT THE TRASH BAG

A. Use the three holes in the top of the bin to secure the bag in the bin.

B. Lock the bag with the top of the bin.

