

BLOOM

COAT HANGER, FLOOR STANDING

ASSEMBLY INSTRUCTION

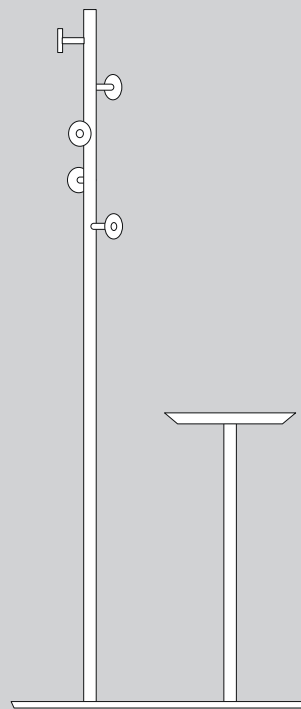
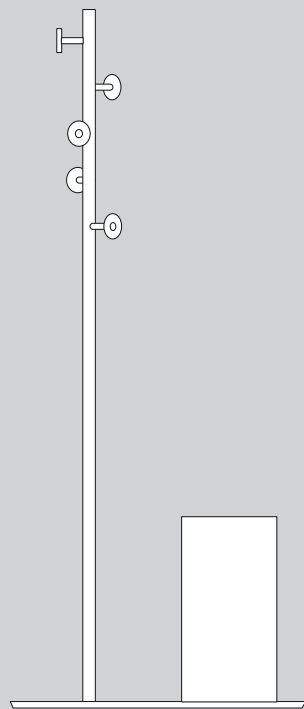
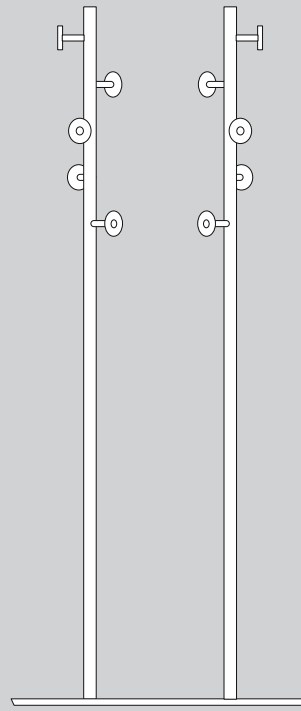
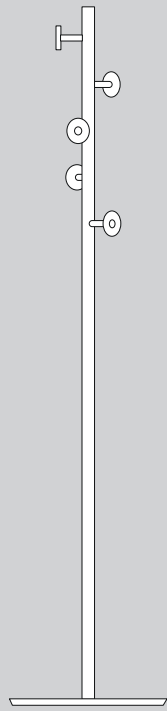

BLOOM FAMILY

Bloom is available in wall-mounted or free-standing variations, and can be combined with different elements to create a warm and welcoming atmosphere.

FLOOR STANDING VARIATIONS

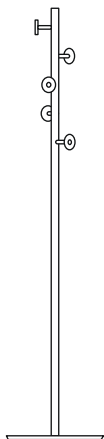

Single coat rack

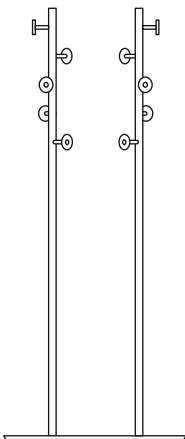

Double coat rack

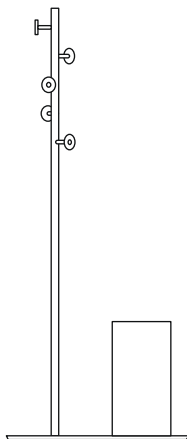

Coat rack + Umbrella stand

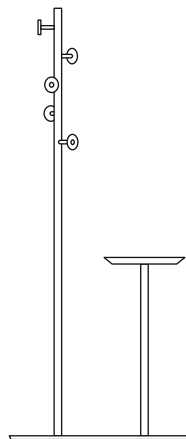

Coat rack + side table

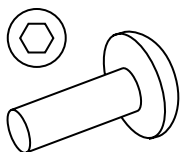

Allen bolt
M8x30mm X2

ADDITIONAL FASTENERS

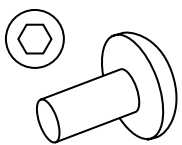

Allen bolt
M8x16mm X2
FOR UMBRELLA STAND

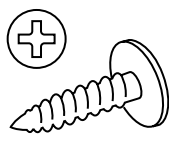

Wood screw
4,2X19mm x3
FOR SIDE TABLE

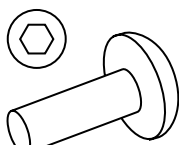

Allen bolt
M8x30mm X2
FOR DOUBLE COAT RACK

TOOLS

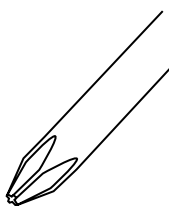

Phillips head Screwdriver
FOR SIDE TABLE

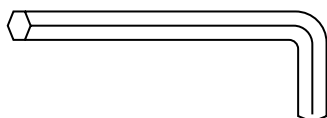

Allen key
5mm

ASSEMBLE BLOOM

Bloom comes in different variations but the process to assemble is the same.

1. ASSEMBLE THE SIDE TABLE (IF INCLUDED)

Use the screwdriver with Phillips head to attach the three Wood screws 4,2x19mm.

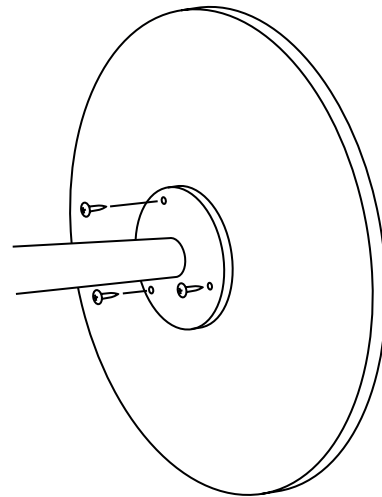

2. ATTACH SINGLE COATRACK + DOUBLE COAT RACK / SIDE TABLE / UMBRELLA STAND

A. Start by tilt the base

B. Attach the Coat Rack with 2 Allen bolts

C. Depending on which variation of Bloom you have, you attach the other variations (Extra coatrack, umbrella stand or table) in the same way.

For Double coat rack or side table, use two Allen bolt M8x30mm.

For Umbrella stand, use two M8x16mm.

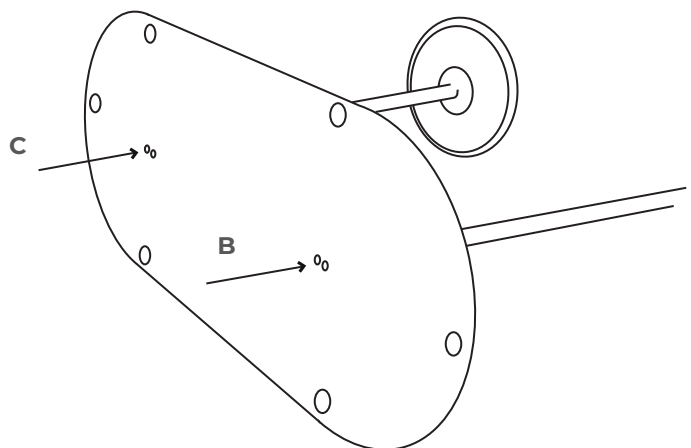
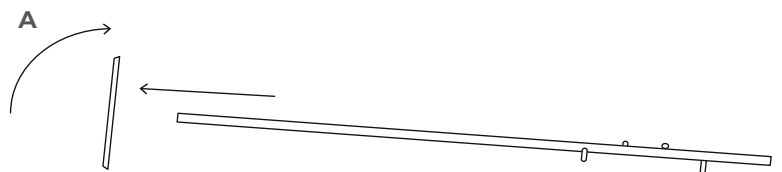

3. ATTACH THE HOOKS

A. Raise the coat rack so it stand on the base

B. Screw in the 5 hooks. No tools needed.

