

BLOOM
COAT HANGER,
WALL MOUNTED
ASSEMBLY INSTRUCTION

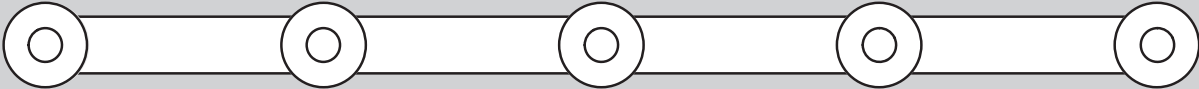

BLOOM FAMILY

Bloom is available in wall-mounted or free-standing variations, and can be combined with different elements to create a warm and welcoming atmosphere.

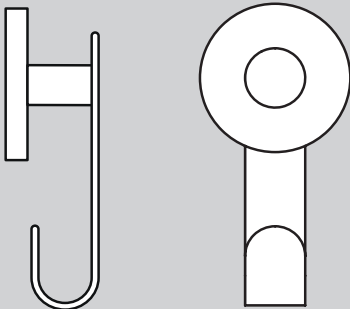
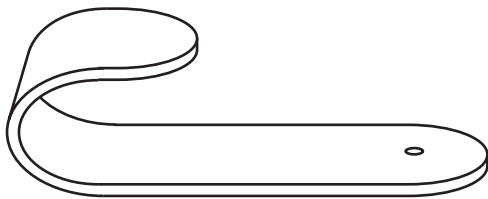

Wall plate

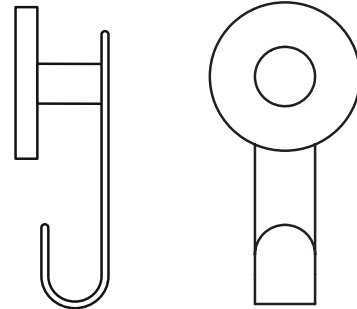

Single Hook

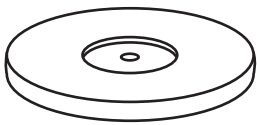

Wood hook
x1



Hook distance
x1

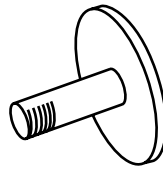

Front bolt
x1

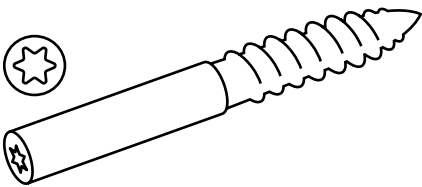

Torx Screw pin
M6X50mm X1

TOOLS

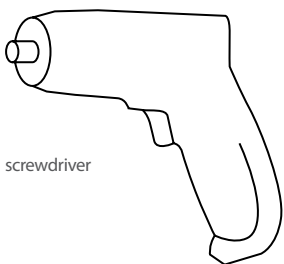

screwdriver

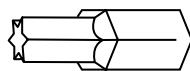

Torx
TX15

THE SINGLE HOOK

1. ASSEMBLE HOOK

Start by assemble the hook. No tools are needed in this step.

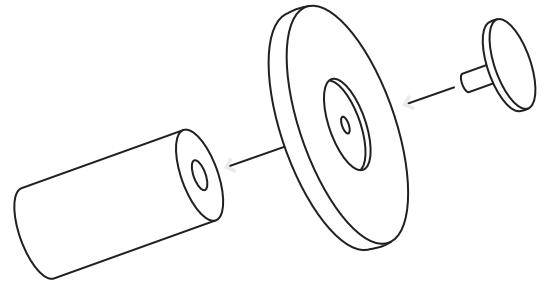

2. PREPAIR THE WALL

Measure out where to drill.

Then screw in the torx screw pin with the screwdriver.

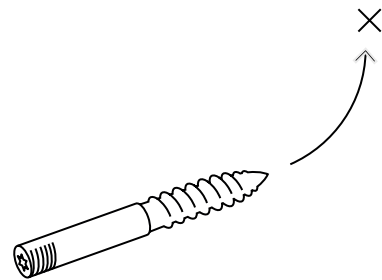

3. SECURE THE WALL PLATE

Now use the wall hook to secure the wall plate. No tools are needed in this step.

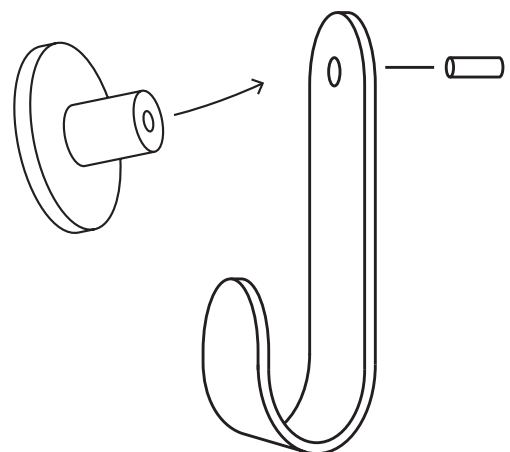

BLOOM FAMILY

Bloom is available in wall-mounted or free-standing variations, and can be combined with different elements to create a warm and welcoming atmosphere.

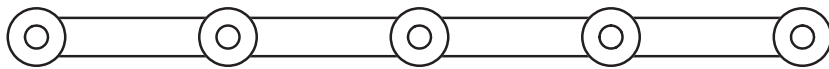

Wall mounted coat rack



Wall plate

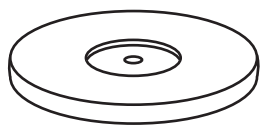

Wood hook
x5



Wall distance
x3

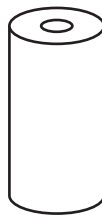

Hook distance
x5

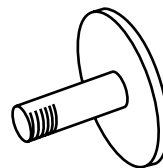

Front bolt
x5

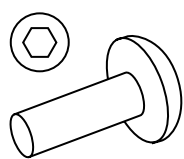

Allen bolt
M6x16mm X2

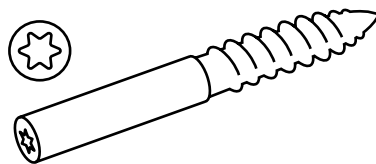

Torx Screw pin
M6X50mm X3

TOOLS

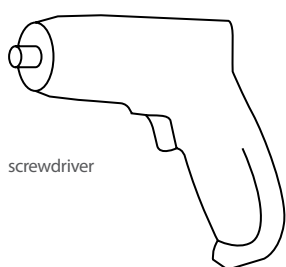

screwdriver

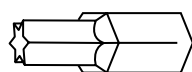

Torx
TX15

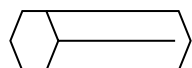

Allen
4mm

THE WALL MOUNTED COAT RACK

1. ASSEMBLE HOOKS

Start by assemble the five hooks. No tools are needed in this step.

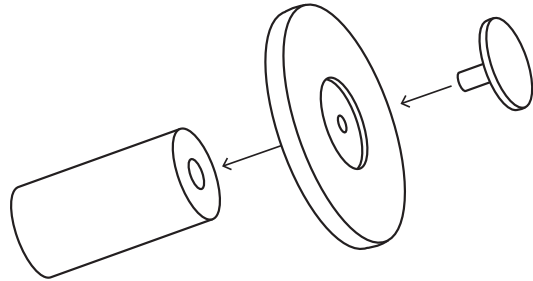

2. MOUNT HOOKS

Mount two of the hooks in the second and fourth hole of the wall plate. Use hex bolts and block key to assemble.

Use two allen bolts M6x16mm.

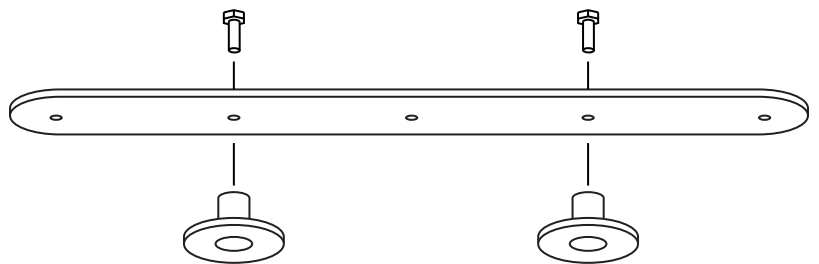

3. PREPARE THE WALL

Measure out three holes with cc400mm. Use a water level to make sure they are horizontal.

Then screw in the torx screw pin with the screwdriver.

Then attach the wall distance.

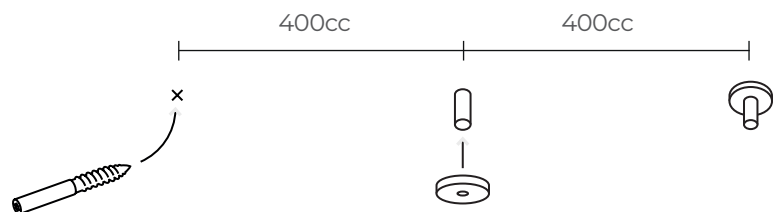

4. MOUNT THE WALL PLATE

With the wall distance on all of the wall pins mount the wall plate.

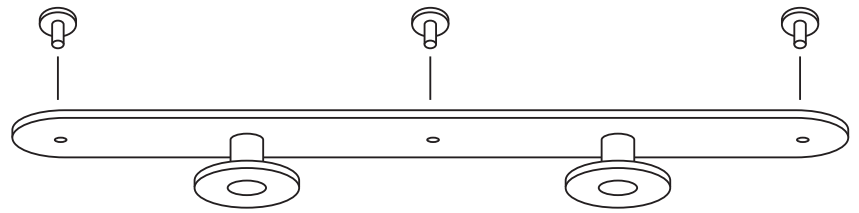

5. SECURE THE WALL PLATE

Now use the three remaining wall hooks to secure the wall plate. No tools are needed in this step.

